

Ball valve with SAE adapter metric / UNC Steel

BKH / BKHP-SAE

Two-way

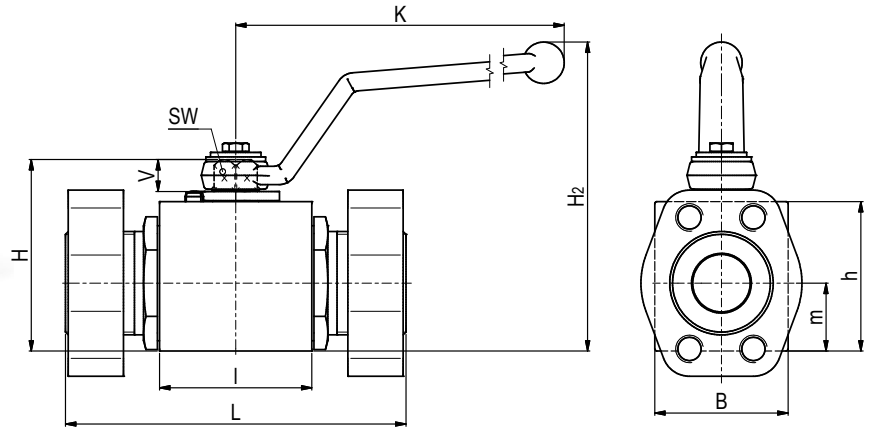
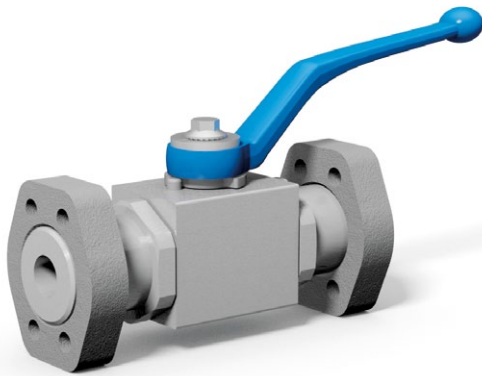

AVAILABLE SIZES

DN13 - DN25 (1/2" to 1")

CONNECTIONS

ISO 6162-1, ISO 6162-2

ACCESSORIES ON REQUEST

- Locking devices page 222 - 225
- Actuators 220 - 221
- Mounting holes 17
- Position switches 228 - 229
- Combinations 184 - 186
- Detent on request

MATERIAL CODE DESCRIPTION

Materials	112A	1128
Body	Steel	Steel
Ball	Steel	Steel
Stem	Steel	Steel
Ball seats	POM	POM
O-rings	NBR	FPM
Tmin / Tmax	-20°C / 100°C	-20°C / 100°C

GENERAL DIMENSIONS

Type	L	B	H	h	m	V	SW	K	H ₂	Lever
BKH-DN13	48	35	54	40	19	11	9	115	89	Zn
BKH-DN20	62	49	75	57	24,5	14	14	171	127	St
BKH-DN25	66	58	83	65	29,5	14	14	171	135	St
BKHP-DN25	74	70	88	70	34,5	14	14	171	140	St

Please note the pressure ratings of the connection flanges!

Ball valve with SAE adapter metric / UNC Steel

BKH / BKHP-SAE

CONNECTION TYPE	DIMENSIONS											ORDER CODE PER MATERIAL COMBINATION		
	Type	LW	L	B ₁	b ₁	t	a	b	M	Weight [Kg]	PN [bar]	112A	1128	
	BKH-DN13-SAE210	13	120	48	56	13	17,5	38,1	M8	1,50	350	32986	30024	
	BKH-DN20-SAE210	20	136	50	65	14	22,2	47,6	M10	3,00	350	30124	29967	
	BKH-DN25-SAE210	25	148	60	70	16	26,2	52,4	M10	4,50	320	23290	30025	
	BKH-DN13-SAE210	13	120	48	56	13	17,5	38,1	5/16" UNC	1,50	350	37789	37790	
	BKH-DN20-SAE210	20	136	50	65	14	22,2	47,6	3/8" UNC	3,00	350	37791	37792	
	BKH-DN25-SAE210	25	148	60	70	16	26,2	52,4	3/8" UNC	4,50	320	37793	37794	

CONNECTION TYPE	DIMENSIONS											ORDER CODE PER MATERIAL COMBINATION		
	Type	LW	L	B ₁	b ₁	t	a	b	M	Weight [Kg]	PN [bar]	112A	1128	
	BKH-DN13-SAE420	13	120	48	56	16	18,2	40,5	M8	1,50	420	32988	37584	
	BKH-DN20-SAE420	20	136	60	71	19	23,8	50,8	M10	2,75	420	25407	37585	
	BKH-DN25-SAE420	25	148	70	81	24	27,8	57,2	M12	3,80	350	25408	37586	
	BKHP-DN25-SAE420	25	156	70	81	24	27,8	57,2	M12	4,50	420	49285	53456	
	BKH-DN13-SAE420	13	120	48	56	16	18,2	40,5	5/16" UNC	1,50	420	37795	37796	
	BKH-DN20-SAE420	20	136	60	71	19	23,8	50,8	3/8" UNC	2,75	420	37797	37798	
	BKH-DN25-SAE420	25	148	70	81	24	27,8	57,2	7/16" UNC	3,80	350	37799	37800	
	BKHP-DN25-SAE420	25	156	70	81	24	27,8	57,2	7/16" UNC	4,50	420	53457	53458	

Two-way