

Locking device type 2 Steel

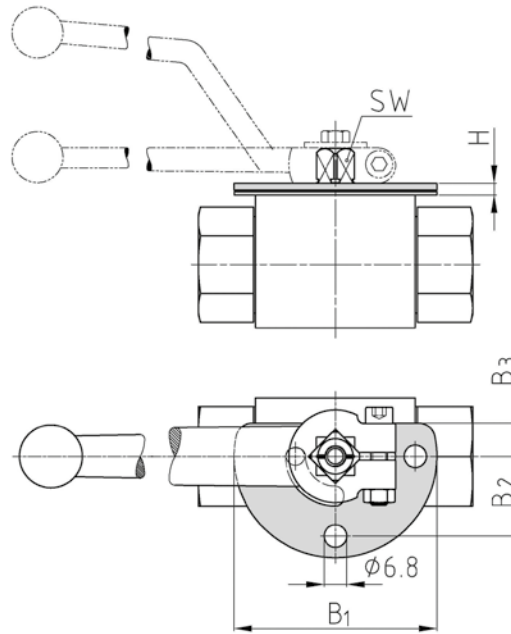

- Suitable as retrofit
- Economical solution
- Can be dismantled after disassembly of lever

DIMENSIONS						ORDER CODE PER MATERIAL		
DN	SW	H	B ₁	B ₂	B ₃	Steel	Stainless Steel	*Article usually in stock.
4-8	9	3,5	61	24	10	052 35082*	on request	
10-13	9	3,5	61	24	10	052 30594*	on request	
16	12	4,5	64	25,5	12	052 30595*	on request	
20-25	14	4,5	84	35,5	14	052 30596*	on request	
32-50	17	4,5	136	61,5	15	052 30597*	on request	

ORDER EXAMPLE

Mounting set consisting of locking plate, stopping disk and ring:

order text	article no.
Locking device type 2 for ball valve DN 4-8	052 35082

Assembled with ball valves:

ball valve type (ball valve design: see data sheets)	article no.	description
BKH - DN13 - G1/2 - 112A	17253	with locking device type 2

MOUNTING SETS ARE VALID FOR

Type	BKH	BKH-AS	MKHP420 Steel	MKHP-AS Steel	BKH / BKH-SAE	MKHP-SAE Steel	BKH / BKHP- SAEFS	MKHP-SAEFS Steel	BK3 ≤ DN25
Page	16 - 23	36	24 - 26	37	48 - 51	52 - 53	40 - 43	44 - 45	94 - 97