

Locking device type 3 Stainless steel

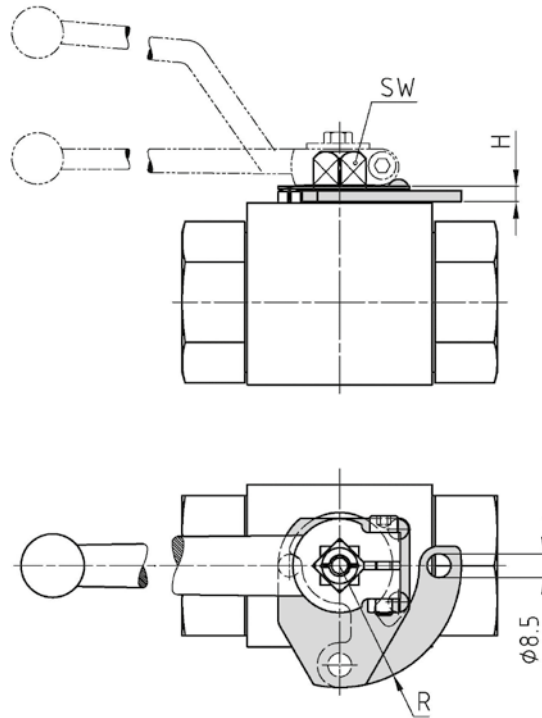

- Not suitable as retrofit
- Economical solution
- Cannot be dismantled
- High security against tampering disassembly

DIMENSIONS				ORDER CODE PER MATERIAL	
DN	SW	H	R	Stainless Steel	
4-13	9	4	37	052 34095	
16	12	4,3	40	052 34279	
20-25	14	5,5	43,5	052 33499	
32-50	17	6	69,5	052 33506	

ORDER EXAMPLE

Available only mounted with ball valve:

ball valve type
(ball valve design: see data sheets)

article no.

description

BKH - DN13 - G1/2 - 112A

- on request

- with locking device type 3

MOUNTING SETS ARE VALID FOR

Type	BKH	BKH-AS	MKHP420 Steel	MKHP-AS Steel	BK3 ≤ DN25
Page	16 - 23	36	24 - 26	37	94 - 97